



# DR. MIROSLAV NOVAK

archival councillor

---

Regional Archives Maribor

Glavni trg 7

SI-2000 Maribor

E-mail: [miro.novak@pokarh-mb.si](mailto:miro.novak@pokarh-mb.si)

Tel.: +00 386 41 526 529

Tel.: +00 386 2 28 50 13

# Introduction...

Document life cycle...



Active...

**YESTERDAY**



Passive...

# Introduction...

Document life cycle...



Active...

**TODAY**



Passive...

# Introduction...

---

Used icon:



**Archival Professional activities in traditional environment - (before computer period).**



**Archival Professional activities in electronic environment - (in computer period).**

# BASIC ARCHIVAL PROBLEMS...

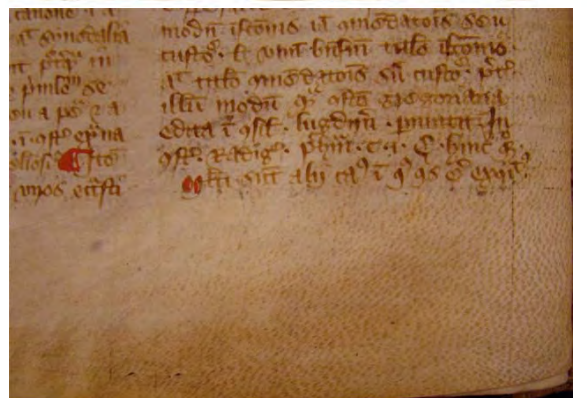

**MEDIA**

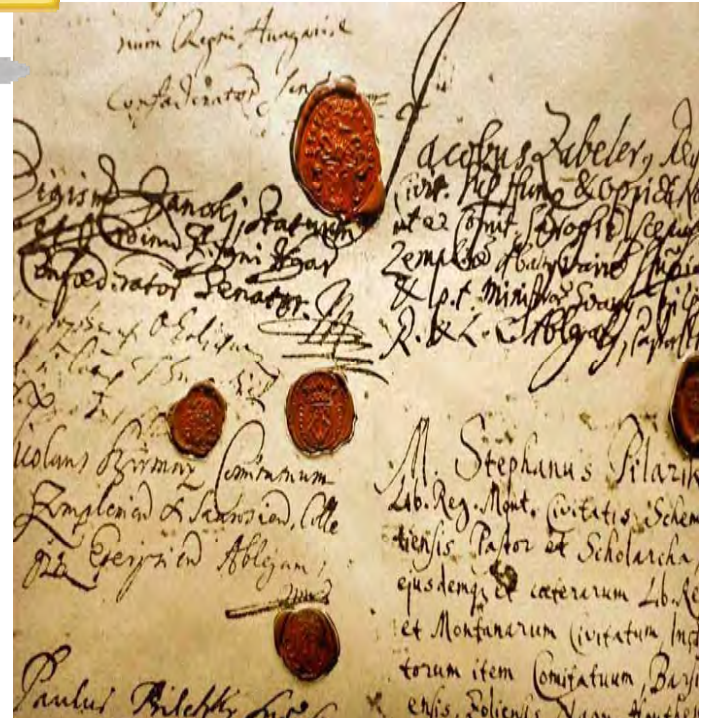

# BASIC ARCHIVAL PROBLEMS...

MATRONIS·A  
FLIABVS·M·M  
ARIVS·KGCEI  
DPQYXZJ UW

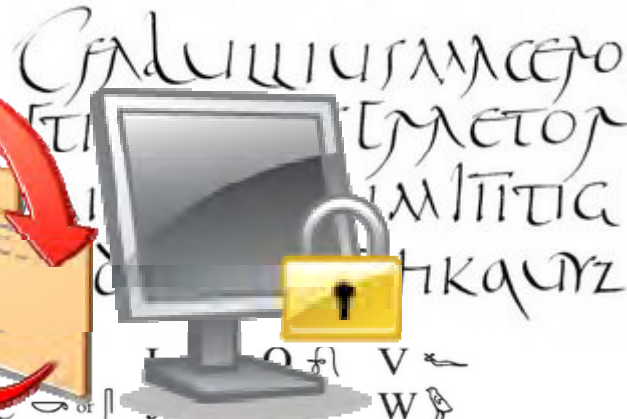

Im Bernbiet, aber ich sage nicht  
wo, liegt ein Bauernhof am son-  
nigen Rain. Bei djfkpqswwxyz

A B C D E F G H I J K L M N  
O P Q R S T U V W X Y Z

1234567890

D K Q X   
E or or R Y or   
F L S Z   
G M T SH

Sic splendete domo, claris na-  
talibus orta Scintillas, raraque  
tuos virtu & ffghjkwxyz œæ?  
RARAQUE TUOS VIR-  
TUTE PARENTES ILLU  
FGKHW JXMYDBNCIZ

1234567890

1	𐤀	10	𐤁	100	𐤂	1000	𐤃
2	𐤄	20	𐤅	200	𐤆	2000	𐤇
3	𐤈	30	𐤉	300	𐤊	3000	𐤋
4	𐤌	40	𐤍	400	𐤎	4000	𐤏
5	𐤐	50	𐤑	500	𐤒	5000	𐤓
6	𐤔	60	𐤕	600	𐤖	6000	𐤗
7	𐤘	70	𐤙	700	𐤚	7000	𐤛
8	𐤜	80	𐤝	800	𐤞	8000	𐤟
9	𐤠	90	𐤡	900	𐤢	9000	𐤣

Hieratic numerals

Different  
writings ....

# Teče mi vodica.

Mirno  $\text{♩} = 42$  (Narodna)  
 Za. mrak, 2. izd. pr. P. Zlatarovič

Te-če mi te-če vo-di-ca,  
 jou-či se jou-či va-le-sče boš,

skouzta-ga mousta zi-da-no-ga, de se j;  
 da-re bom gjes ksou-da-tom šou

lú-bi-ca zmuva-la mi-lo se jou-ka-la.  
 kraja van drtigi kraj, né dá ma več na zaj.

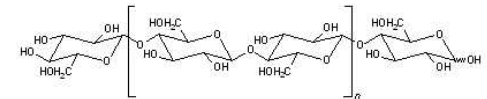
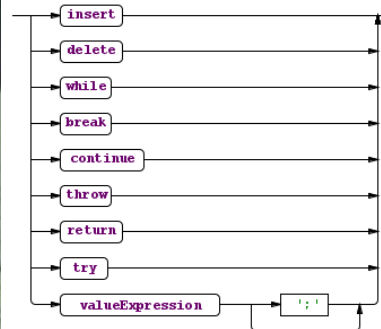
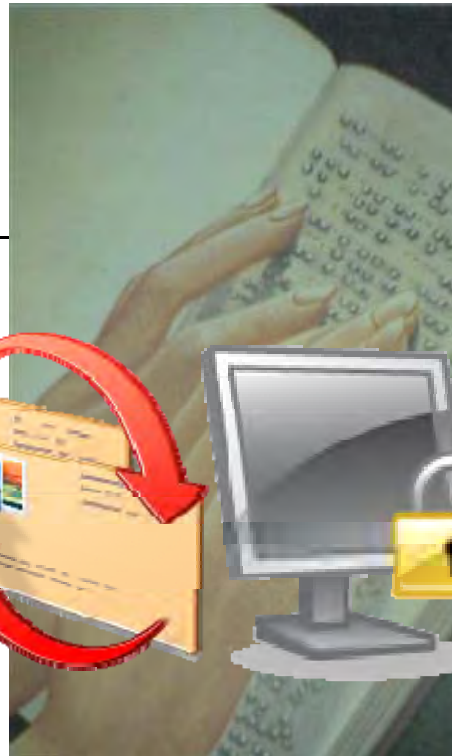

Molekula celuloze

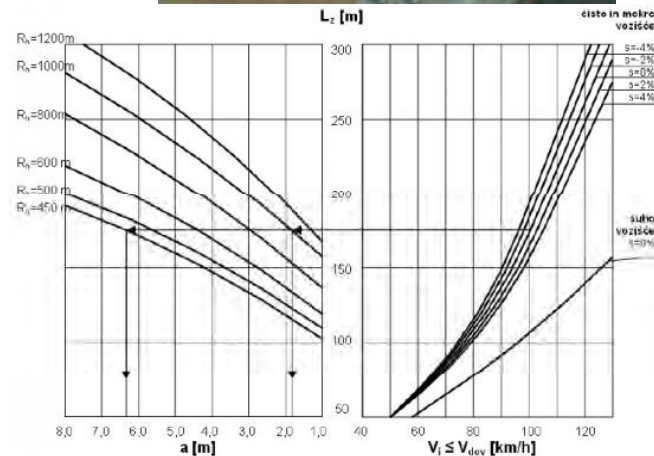
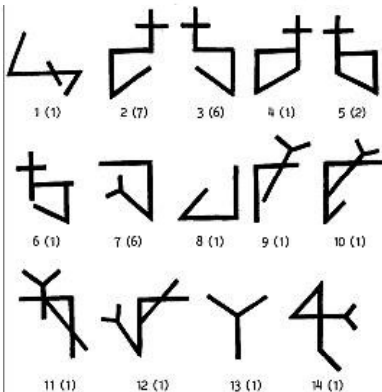

Slika III-2: Soodvisnost polmera  $R_0$ , razdalje  $a$ , hitrosti  $V_1$  in nagiba nivelete  $s$  (povzeto po: RAS-L, 1995)

## METEOROGRAM

Latitude: 46.04 Longitude: 14.34

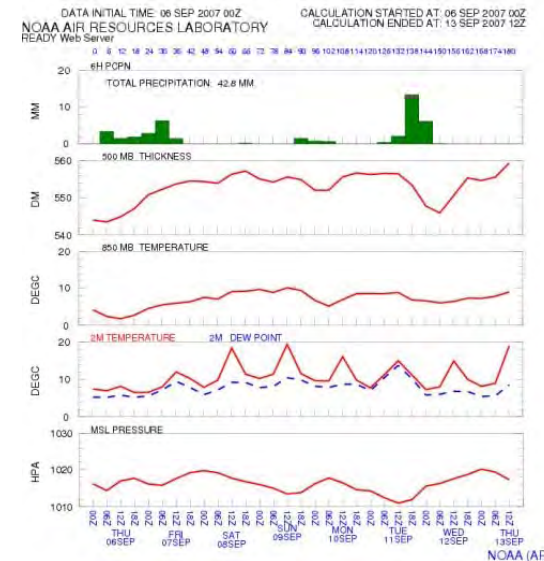

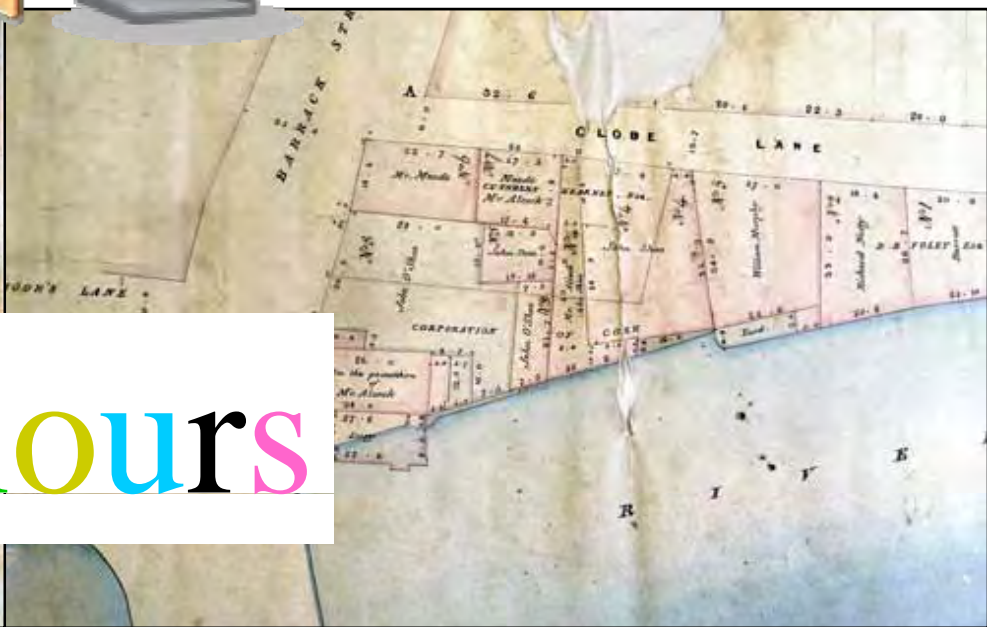

colours





**INTERSPAR**

SPAR SLOVENIJA d.o.o.  
 Letalska c. 26, 1000 Ljubljana  
 ID OOV: 5132156782  
 INTERSPAR mesenarke!  
 cesta 1. maja 77, 4000 Kranj  
 Tel. 04-28-16-700

---

OPRTO  
 PON-PET 9:00 - 21:00  
 SOBOTA 8:00 - 21:00  
 NEDELJA 9:00 - 15:00

---

12 x 0.62  
 MLEKO TRAJNO BENEFIT 7.44 B  
 SPAR MOKRO PSEN 1500 ING. 0.45 B  
 SPAR SUCIJA SI 35 500G 0.55 B  
 CILJARITA CEBULA 100m 0.79 B

---

VSOTA EUR 9.23  
 SIT 2211.88

---

DRL BR 9.23

---

R= 0.00 B, B= B.50 %, C=20.00 %  
 OOV NETO OOV BRUTO  
 B 8.51 0.72 9.23

KLUB STROJNICEV KRAJNA  
 18. 02. 2006

KLUB STROJNICEV KRAJNA  
 18. 02. 2006

ŠIFRA	NAZIV ARTIKLA	EM	PODST
0018864	LEDO CLICKITS 800g	3,876,00	3,876,00
0018864	LEDO CLICKITS 800g	-1,000,00	-3,076,00
0004559	KARIZI 200g PETEKOT	1,000,00	29,00
0002577	INVAZI/100g EMERSON	1,000,00	1,050,00
0003757	IGRA 25002 SPONICA	1,000,00	2,580,00
0009733	DETERJIV 90044200g	1,000,00	1,370,00

Vrednost brez OOV: 5.380,00  
 ZA PLACILO 6.360,00

**LOGOTIP POJUTJA** Proletarska c. 4, 1000 Ljubljana, Slovenija

**Amadej d.o.o.**  
 Proletarska c. 4  
 1000 Ljubljana

**RAČUN Št. 00022-A1000-1-2007**  
 Kraj: Ljubljana  
 Datum opravljenе dobave blaga oz. opravljenе storitve: 22.11.2007  
 Ident. št. za DDV naročnika: S116034392

Datum računa: 22.11.2007  
 Datum valute: 30.11.2007  
 Plačilna valuta: EUR

**Zaračunavamo vam naslednje:**

Matič.	Cena	Količ.	Vrednost	Pop	Davčna	DDV	Znesek z DDV
1	18000	35,4999	1	KOS	35,47	0	35,47
2	15660	5	KOS	9,83	10	8,85	20,52

Skupaj vrednost: 45,30  
 Popust na izdatke: 0,98  
 Osnova 20%: 44,32  
 DDV 20%: 8,86

**Združene Vev** Vedvo d. d.  
 Industriestrasse 60, 1000 Ljubljana, Slovenija

**Isiistoffwerk GÖrtzschach, Heisstofffabrik**  
 Görtzschach

Vedel Vedvo prej naročila v dne 10. XII. 1994. in v smislu Vam prodanih in dobavih pogojev ama. Vam postali na Vedo odgovornost in na Ved račun.

Števil	Teles	Cena	Zevsk
1	11,000	450,-	6,100,45

**ELEKTRO MARIBOR**  
 Trzinova ulica 8, 2000 Maribor

TRIN: 04315-030571038  
 Davčni številka: 46479632  
 OE MARIBOR MESTO

IZJAVILNI, 01.10.2002  
 Datum izjave: 19.10.2002

Številka računa: 2751582  
 za predloženo dobavo električne opreme v času od 18.09.2002 do 18.10.2002

Številka: 0010121610014  
 Št. obj. mesta: 001012161004  
 Št. števca: 303199  
 Tarifni skupaj: 22 OOSP. I.B.T.  
 Akcijski strošek: 10025 A  
 (Zbirni strošek)

Številka računa: 2751582

Št.	Št.	Številka	NETO	Čena št.	Številka št.
25	16,16	443,91			
26	16,81	265,64			
1	1873,10	1.722,30			

Vrednost brez OOV: 5.380,00  
 ZA PLACILO 6.360,00

# Diversity of archival material

Otvorena ime: **Brox**  
 Tipus: **Jašica**  
 Fotografija: 

Osobni opis:  
 Vrsta: **glava**  
 Izmjere tijela: **16**

Sposobnosti:  
 Praktika:  
 Obilježja: **D. O. B.**



**Skladišna kartoteka**

Š. 175    Cena: na debelo 455,00    na drožno 415,84    lastna 124,00

Ime blaga - dobavitelj: **DOBAVNICA / AS**

Merska enota: **KOS**

Datum	Št. dobav.	Projem	Oddaja	Zaloga	Datum	Št. dobav.	Projem	Oddaja	Zaloga
1.1.2002				3.210					
7.1.2002	8/02	10.000		13.210					
1.1.2002	10/02		750	12.460					

2564 - 96    Poručak prepovedati: **ALEA** 025 t.i.d. ZALOŽNIŠTVO TRBOVIN    Skladišna kartoteka - Obr. 5,55

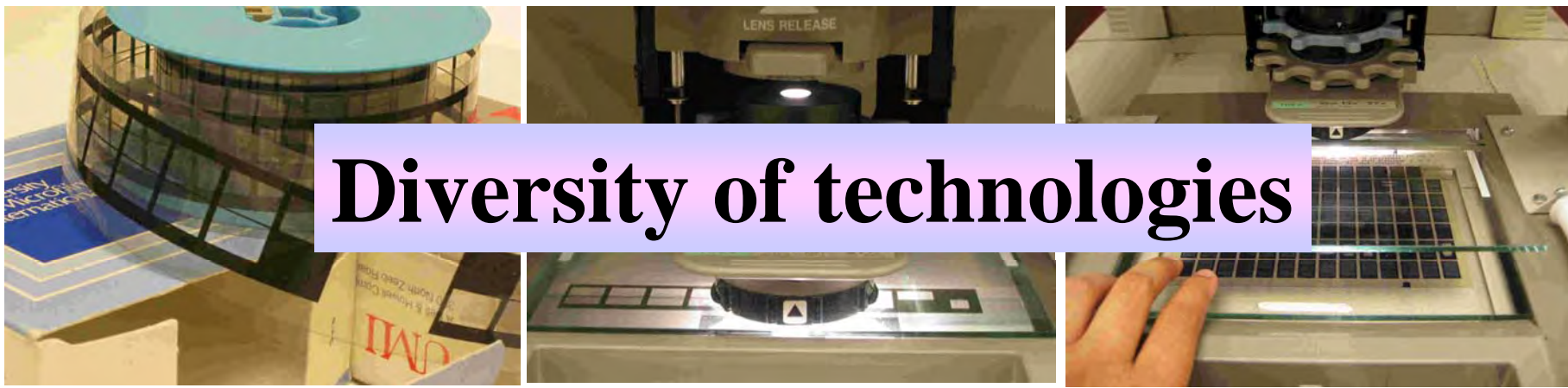

**Diversity of technologies**



Size of documents

# BASIC ARCHIVAL PROBLEMS...

---

Hi Miroslav,

I noticed this morning that your translate module was broken and I took the liberty of making some adjustments to it. I was concerned that you deleted the Townley and Matheson folders from the record and the City of Vancouver Archives record, which was tied to. See the message on google discussions at [http://groups.google.ca/group/ica-atom-users/browse\\_thread/thread/500d173fa7659374?hl=en#](http://groups.google.ca/group/ica-atom-users/browse_thread/thread/500d173fa7659374?hl=en#)



This is a problem we didn't think about when we set up the sites, so it's not your fault, but for now, in order for the translate module to work, you'll have to leave the records in there. You'll note I only added back the titles.

Let me know if you have any questions or concerns about this.

## Dematerialization of documents



# BASIC ARCHIVAL PROBLEMS...

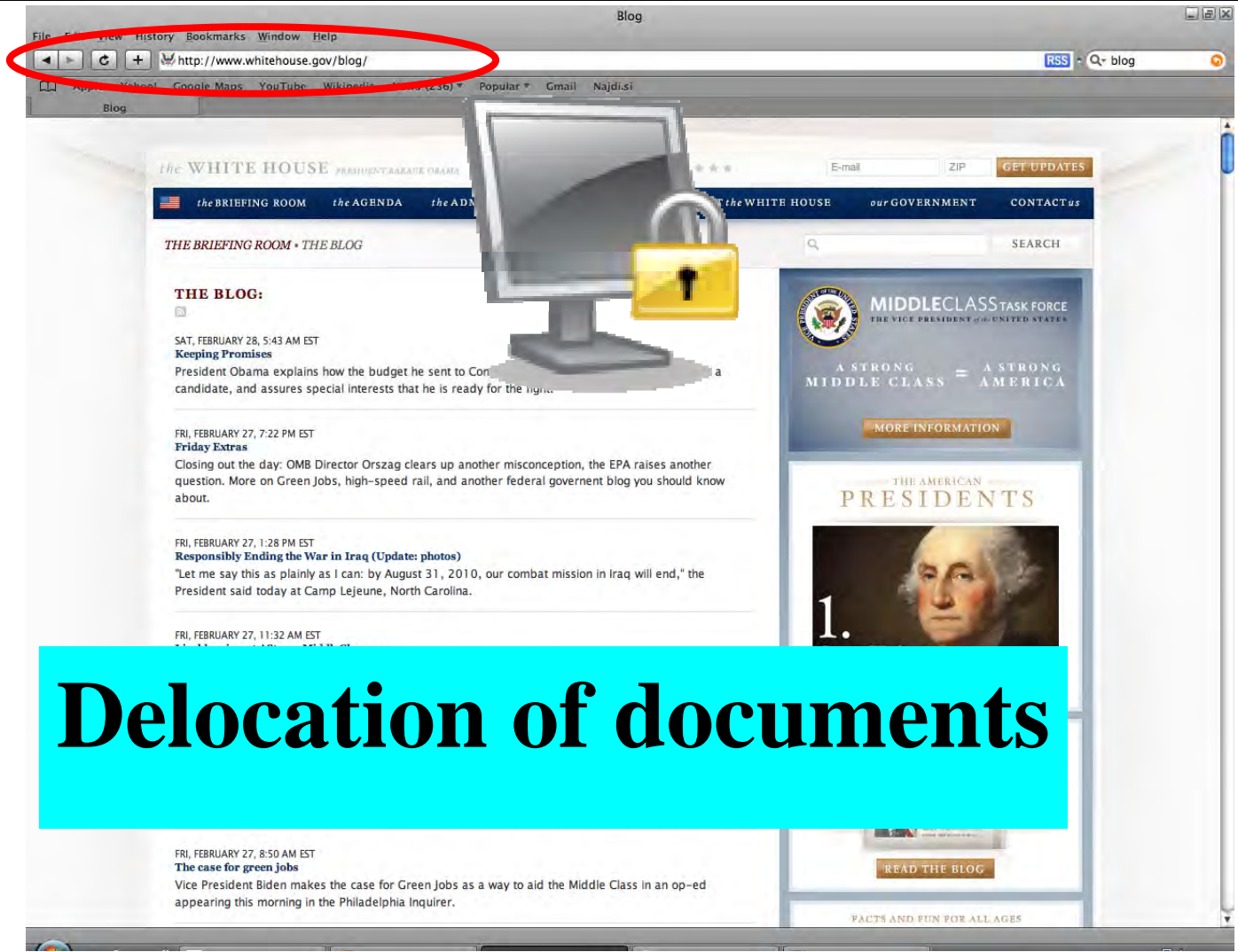

The image shows a screenshot of a web browser displaying the White House blog. A red circle highlights the address bar containing the URL <http://www.whitehouse.gov/blog/>. A yellow padlock icon is overlaid on the browser window, symbolizing access restrictions or archival issues. The page content includes the White House logo, navigation menus, and a list of blog posts. A large cyan banner at the bottom of the page contains the text "Delocation of documents".

the WHITE HOUSE PRESIDENT BARACK OBAMA

the BRIEFING ROOM the AGENDA the ADDRESS

THE BRIEFING ROOM • THE BLOG

**THE BLOG:**

SAT, FEBRUARY 28, 5:43 AM EST  
**Keeping Promises**  
President Obama explains how the budget he sent to Congress... a candidate, and assures special interests that he is ready for the high...

FRI, FEBRUARY 27, 7:22 PM EST  
**Friday Extras**  
Closing out the day: OMB Director Orszag clears up another misconception, the EPA raises another question. More on Green Jobs, high-speed rail, and another federal government blog you should know about.

FRI, FEBRUARY 27, 1:28 PM EST  
**Responsibly Ending the War in Iraq (Update: photos)**  
"Let me say this as plainly as I can: by August 31, 2010, our combat mission in Iraq will end," the President said today at Camp Lejeune, North Carolina.

FRI, FEBRUARY 27, 11:32 AM EST

MIDDLECLASS TASK FORCE  
THE VICE PRESIDENT OF THE UNITED STATES  
A STRONG MIDDLE CLASS = A STRONG AMERICA  
MORE INFORMATION

THE AMERICAN PRESIDENTS  
1.

**Delocation of documents**

FRI, FEBRUARY 27, 8:50 AM EST  
**The case for green jobs**  
Vice President Biden makes the case for Green Jobs as a way to aid the Middle Class in an op-ed appearing this morning in the Philadelphia Inquirer.

FACTS AND FUN FOR ALL AGES

# BASIC ARCHIVAL PROBLEMS...

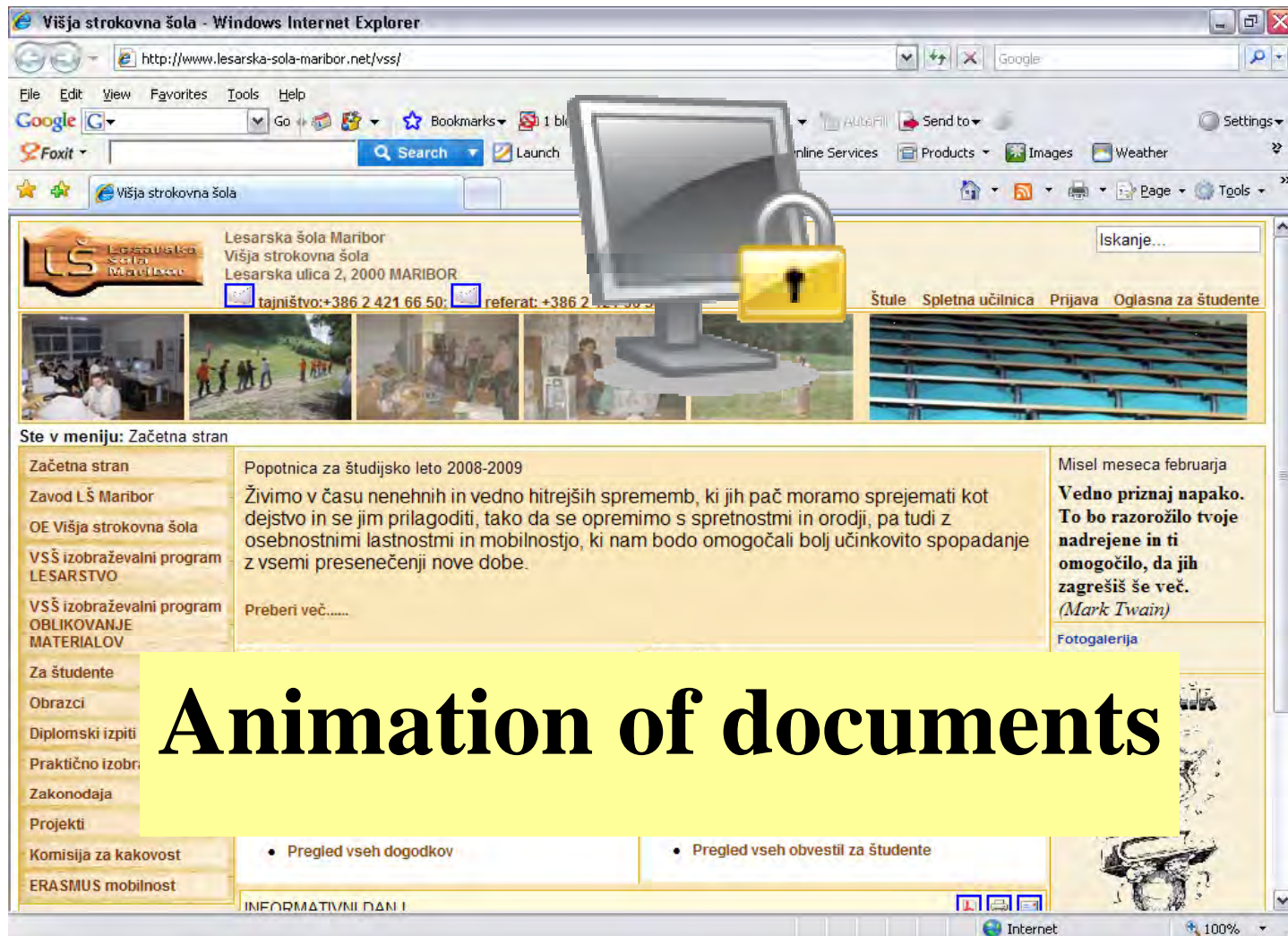

Višja strokovna šola - Windows Internet Explorer

http://www.lesarska-sola-maribor.net/vss/

File Edit View Favorites Tools Help

Google G Go Bookmarks 1 bl

Foxit Search Launch

Višja strokovna šola

Lesarska šola Maribor  
Višja strokovna šola  
Lesarska ulica 2, 2000 MARIBOR  
tajništvo:+386 2 421 66 50; referat:+386 2 421 66 50

Iskanje...

Štule Spletna učilnica Prijava Oglasna za študente

Ste v meniju: Začetna stran

Začetna stran  
Zavod LŠ Maribor  
OE Višja strokovna šola  
VSŠ izobraževalni program LESARSTVO  
VSŠ izobraževalni program OBLIKOVANJE MATERIALOV  
Za študente  
Obrazci  
Diplomski izpiti  
Praktično izobr  
Zakonodaja  
Projekti  
Komisija za kakovost  
ERASMUS mobilnost

Popotnica za študijsko leto 2008-2009  
Živimo v času nenehnih in vedno hitrejših sprememb, ki jih pač moramo sprejemati kot dejstvo in se jim prilagoditi, tako da se opremimo s spretnostmi in orodji, pa tudi z osebnostnimi lastnostmi in mobilnostjo, ki nam bodo omogočali bolj učinkovito spopadanje z vsemi presenečenji nove dobe.  
Preberi več.....

Misel meseca februarja  
**Vedno priznaj napako. To bo razorožilo tvoje nadrejene in ti omogočilo, da jih zagrešiš še več.**  
(Mark Twain)  
Fotogalerija

**Animation of documents**

Pregled vseh dogodkov  
Pregled vseh obvestil za študente

INFORMATIVNI DAN I

Internet 100%

# BASIC ARCHIVAL PROBLEMS...

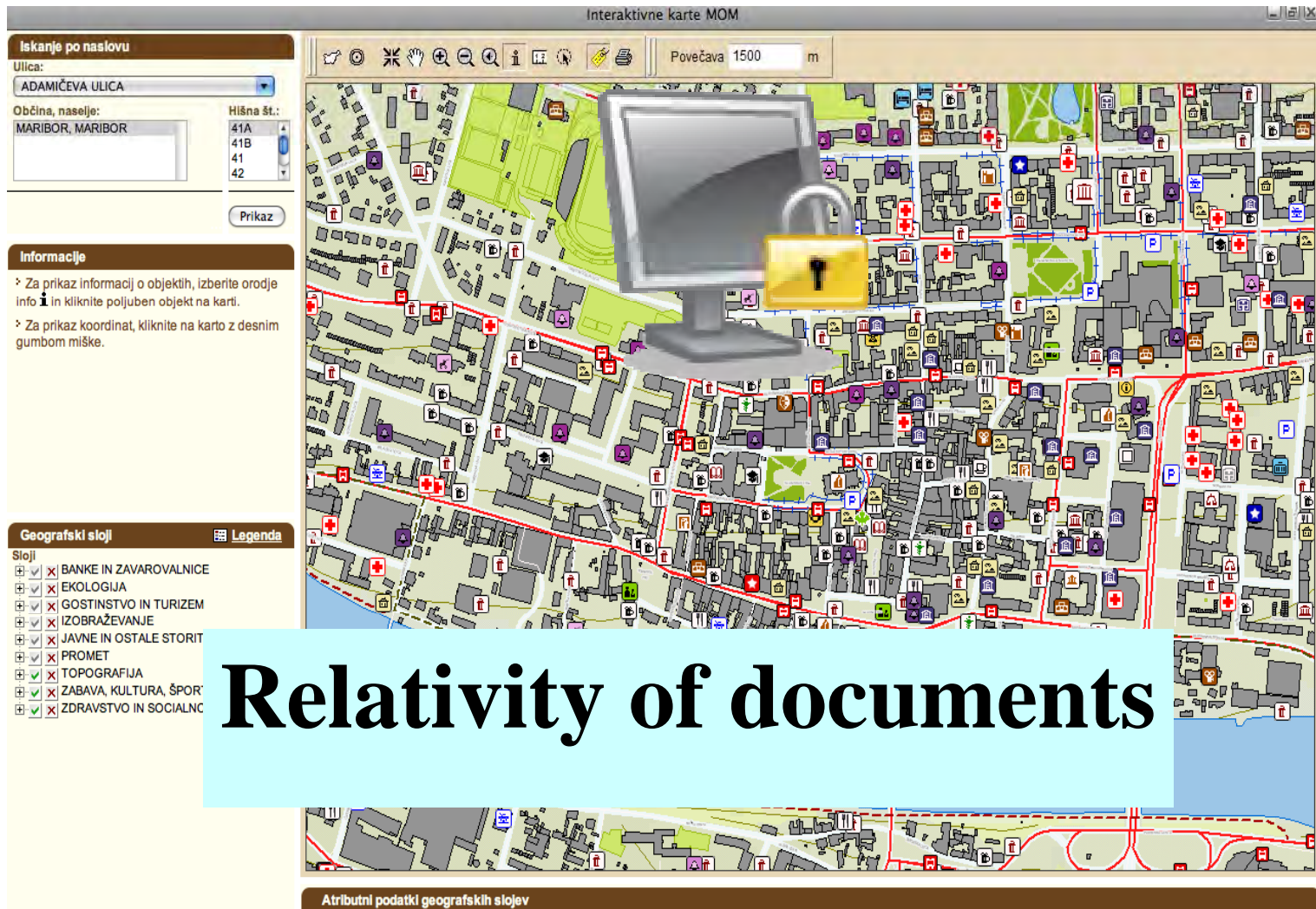

Interaktivne karte MOM

Povečava 1500 m

**Iskanje po naslovu**

Ulica:  
ADAMIČEVA ULICA

Občina, naselje:  
MARIBOR, MARIBOR

Hišna št.:  
41A  
41B  
41  
42

Prikaz

**Informacije**

- Za prikaz informacij o objektih, izberite orodje info  in kliknite poljuben objekt na karti.
- Za prikaz koordinat, kliknite na karto z desnim gumbom miške.

**Geografski sloji**  **Legenda**

Sloji

<input checked="" type="checkbox"/>	<input checked="" type="checkbox"/>	BANKE IN ZAVAROVALNICE
<input checked="" type="checkbox"/>	<input checked="" type="checkbox"/>	EKOLOGIJA
<input checked="" type="checkbox"/>	<input checked="" type="checkbox"/>	GOSTINSTVO IN TURIZEM
<input checked="" type="checkbox"/>	<input checked="" type="checkbox"/>	IZOBRAŽEVANJE
<input checked="" type="checkbox"/>	<input checked="" type="checkbox"/>	JAVNE IN OSTALE STORIT
<input checked="" type="checkbox"/>	<input checked="" type="checkbox"/>	PROMET
<input checked="" type="checkbox"/>	<input checked="" type="checkbox"/>	TOPOGRAFIJA
<input checked="" type="checkbox"/>	<input checked="" type="checkbox"/>	ZABAVA, KULTURA, ŠPOR
<input checked="" type="checkbox"/>	<input checked="" type="checkbox"/>	ZDRAVSTVO IN SOCIALNC

**Relativity of documents**

Atributni podatki geografskih slojev



# BASIC ARCHIVAL PROBLEMS...

The screenshot shows the Europeana website interface in a Windows Internet Explorer browser window. The address bar displays the URL: <http://www.europeana.eu/portal/brief-doc.html?start=1&view=table&query=maribor>. The browser's menu bar includes File, Edit, View, Favorites, Tools, and Help. The search bar contains the text 'europeana'. The page features the Europeana logo with a 'beta' badge and the tagline 'europeana think culture'. Navigation tabs include 'My Europeana', 'Comm...', 'Timeline (beta)', and 'Thought lab'. A search bar with a yellow padlock icon is visible. Below the search bar, the text 'Matches for: maribor' is displayed. The results are categorized into 'All', 'Texts (63)', 'Videos (2)', and 'Sounds (0)'. The page shows 'Results 1 - 12 of 114' and 'Page: 1'. A list of search results is visible, including a document titled 'leta; Maribor 192...'. An orange box with the text 'Agrigation of data' is overlaid on the bottom right of the search results area.

# BASIC ARCHIVAL PROBLEMS...

## CASE: KEEPING OF CONTENT

Tell the people to build a chest of acacia wood forty-five inches long, twenty-seven inches wide, and twenty-seven inches high. <sup>14</sup> Cover it inside and out with pure gold and put a gold edging around

the lid. <sup>12</sup> **Make four gold rings and fasten one of them to each of the four legs of the chest.**

<sup>13</sup> Make two poles of acacia wood. Cover them with gold and put the rings on them, so the chest can be carried by the poles. <sup>15</sup> Don't even remove the poles from the rings. <sup>16</sup> When I give you the chest, <sup>17</sup> take two flat stones, put them inside the chest.

Cover the lid of the chest with gold and put two winged creatures of pure gold and fasten them to

the lid at the ends of the chest. <sup>20</sup> **The creatures face each other with their wings spread over**

**the chest.** <sup>21</sup> Inside it place the two flat stones with the Ten Commandments. <sup>22</sup> I will meet you there

between the two creatures and tell you what my people must do and what they must not do.

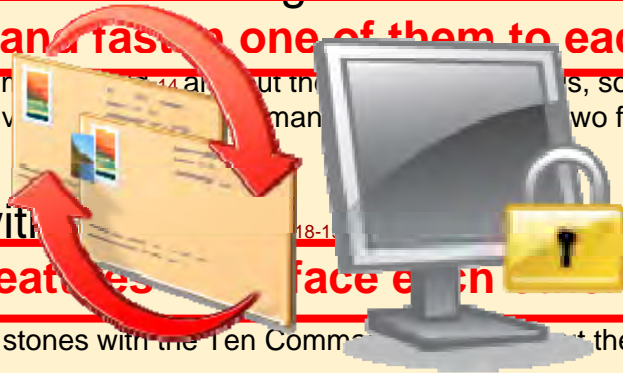

(Exodus 37.1-9) - between 16. and 13. century B.C.

# BASIC ARCHIVAL PROBLEMS...

## CASE: INTERPETATION OF CONTENT

...two winged creatures...



1412-1416

...four gold rings...



1470-1475

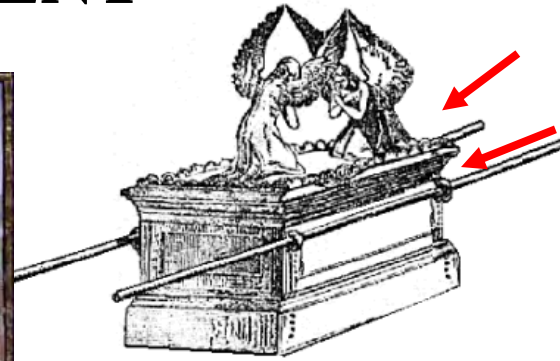

19. century

# POSSIBLE SOLUTION...

---

**S**ecurity

**P**rofessionalism

**S**tandardisation

# POSSIBLE SOLUTION...

---

**S**ecurity

**P**rofessionalism

**S**tandardisation

# ACTUAL FIELDS OF SECURITY/SAFETY

## □ REAL WORLD



## □ VIRTUAL WORLD



# CONCLUSION: WHAT MUST BE PROTECTED IN ARCHIVE?

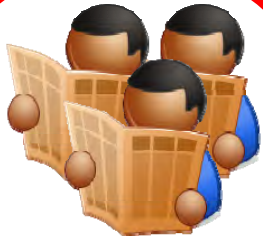

USERS



STAFF

PROCESSES



RESCUE TEAMS

CONTEXT AND OTHER DATA

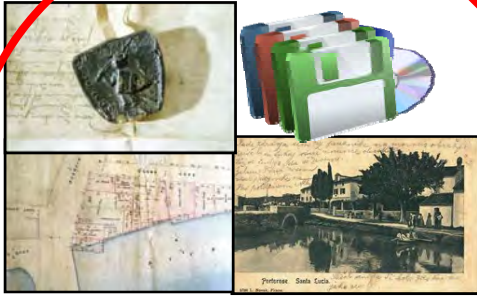
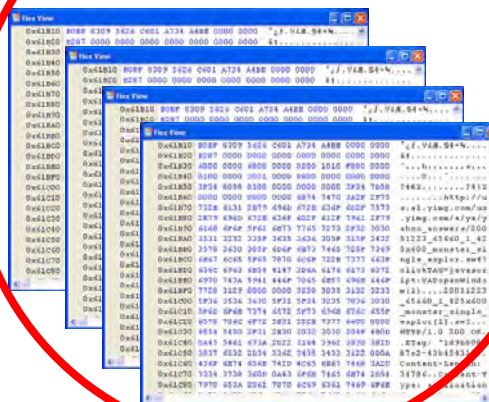

ARCHIVAL MATERIAL

BUILDINGS AND EQUIPMENT



# CASE...

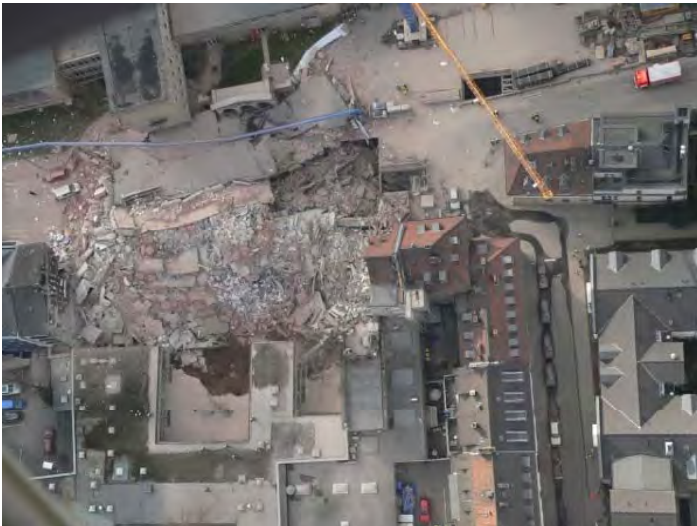

Germany:  
Koeln (2009)



# ACCESS & CONTROL...

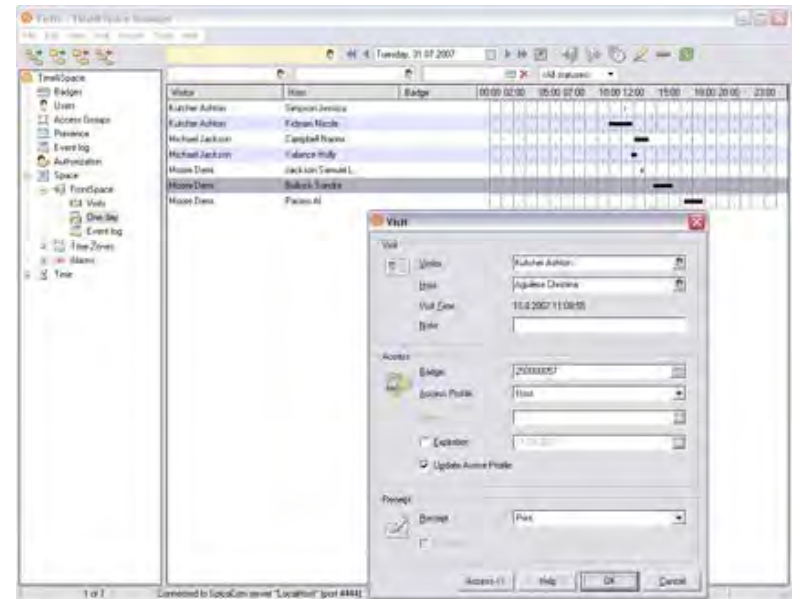
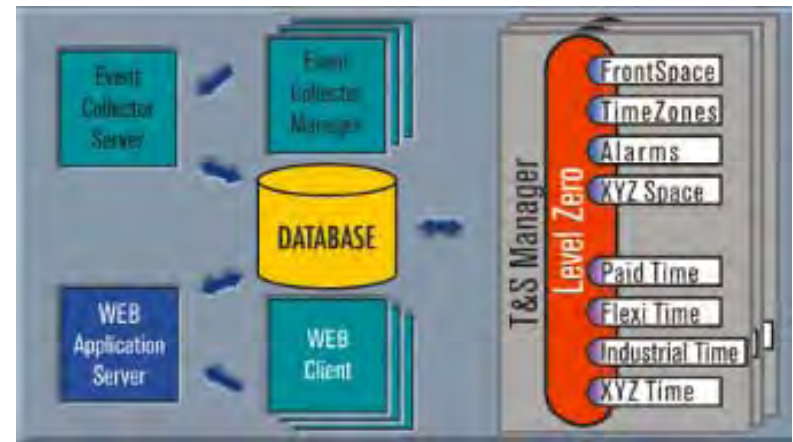
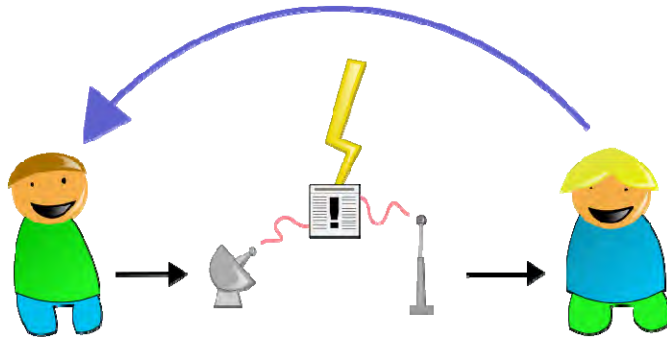

# ANTI [...] SYSTEMS

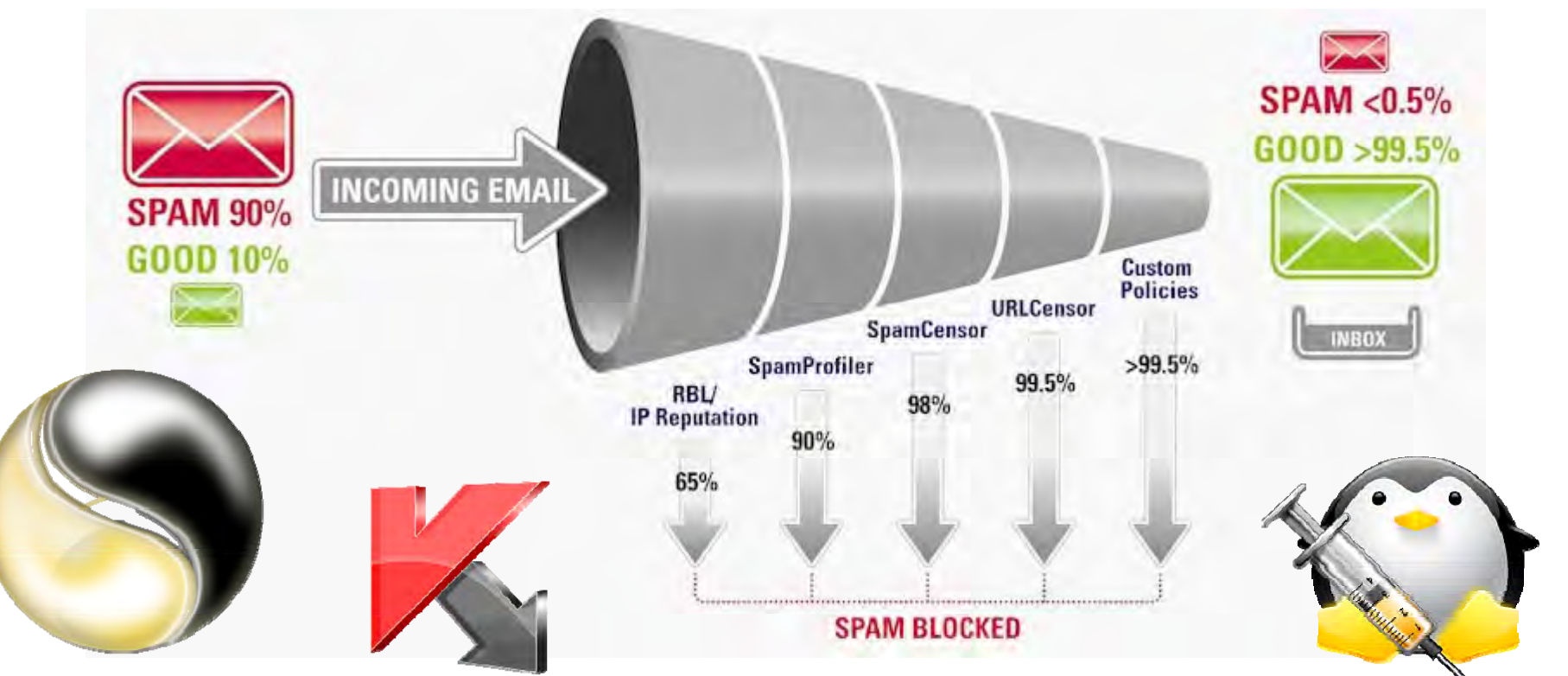

# POSSIBLE SOLUTION...

---

**S**ecurity

**P**rofessionalism

**S**tandardisation

# INTRODUCTION...



Can be destroyed

≈ 85%



≈ 10%

Permanent



≈ 5%

Archival



# AREAS OF PROFESSIONAL ACTIVITIES ...

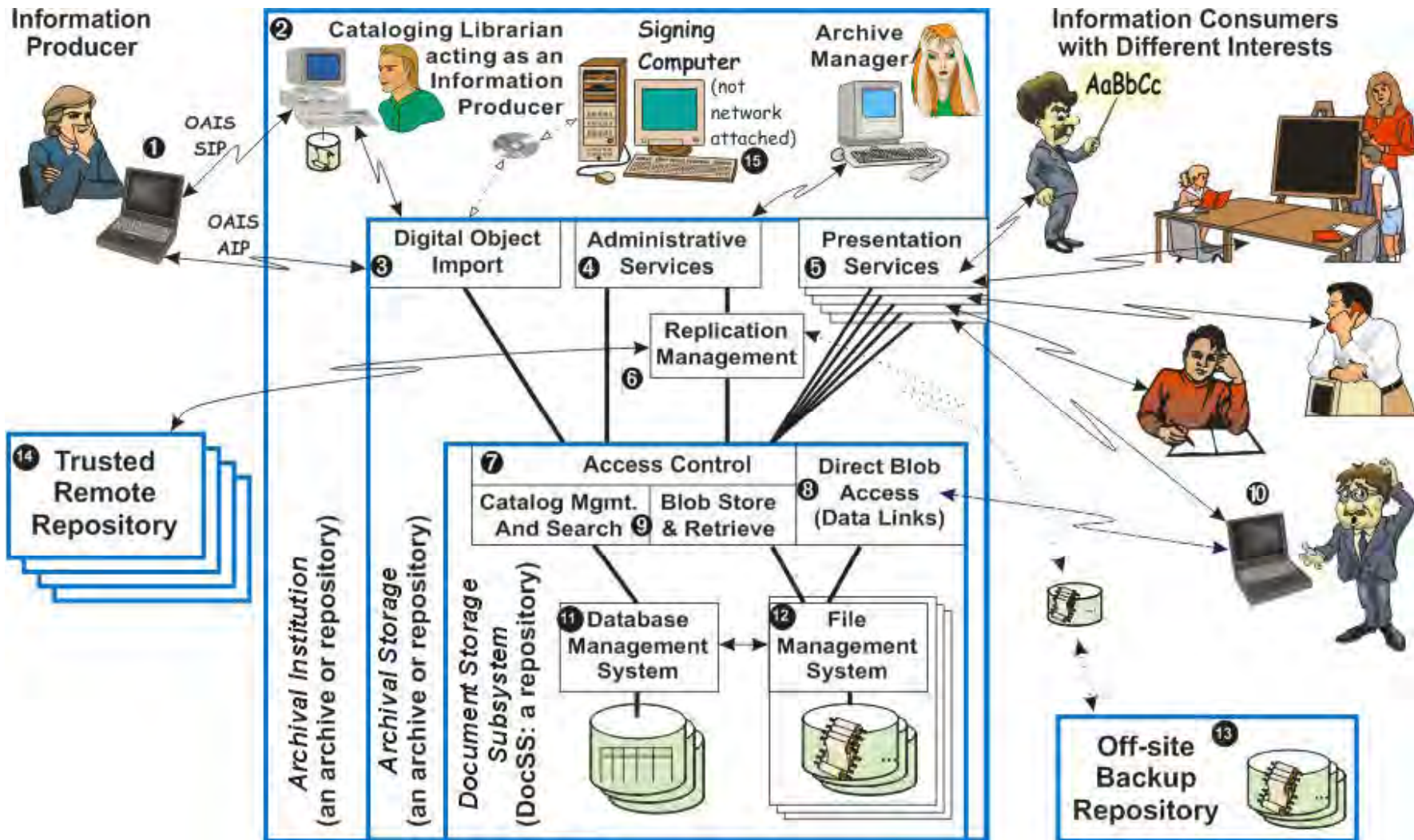

# AREAS OF PROFESSIONAL ACTIVITIES ...

Out of archives

Signal data (information)

In archives

Archival finding aids

Documentation for traditional  
archival material 1...n

Documentation for  
e-archival material 1...n

Paper based original  
archival material

Different type  
of copies

Different type  
of e-copies

Original e-archival material

# QUANTITY OF DATA ELEMENTS...

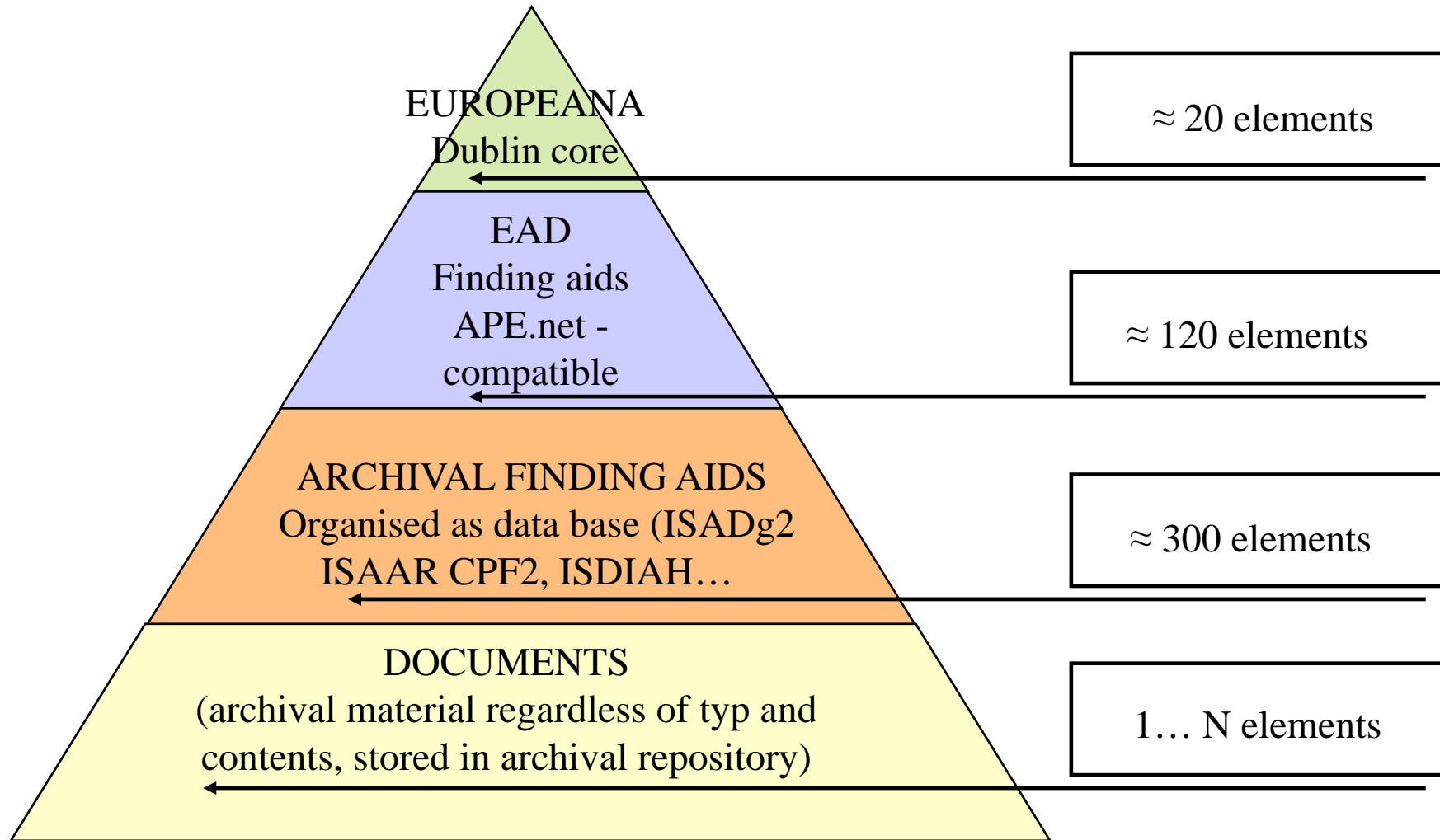

# CASE...

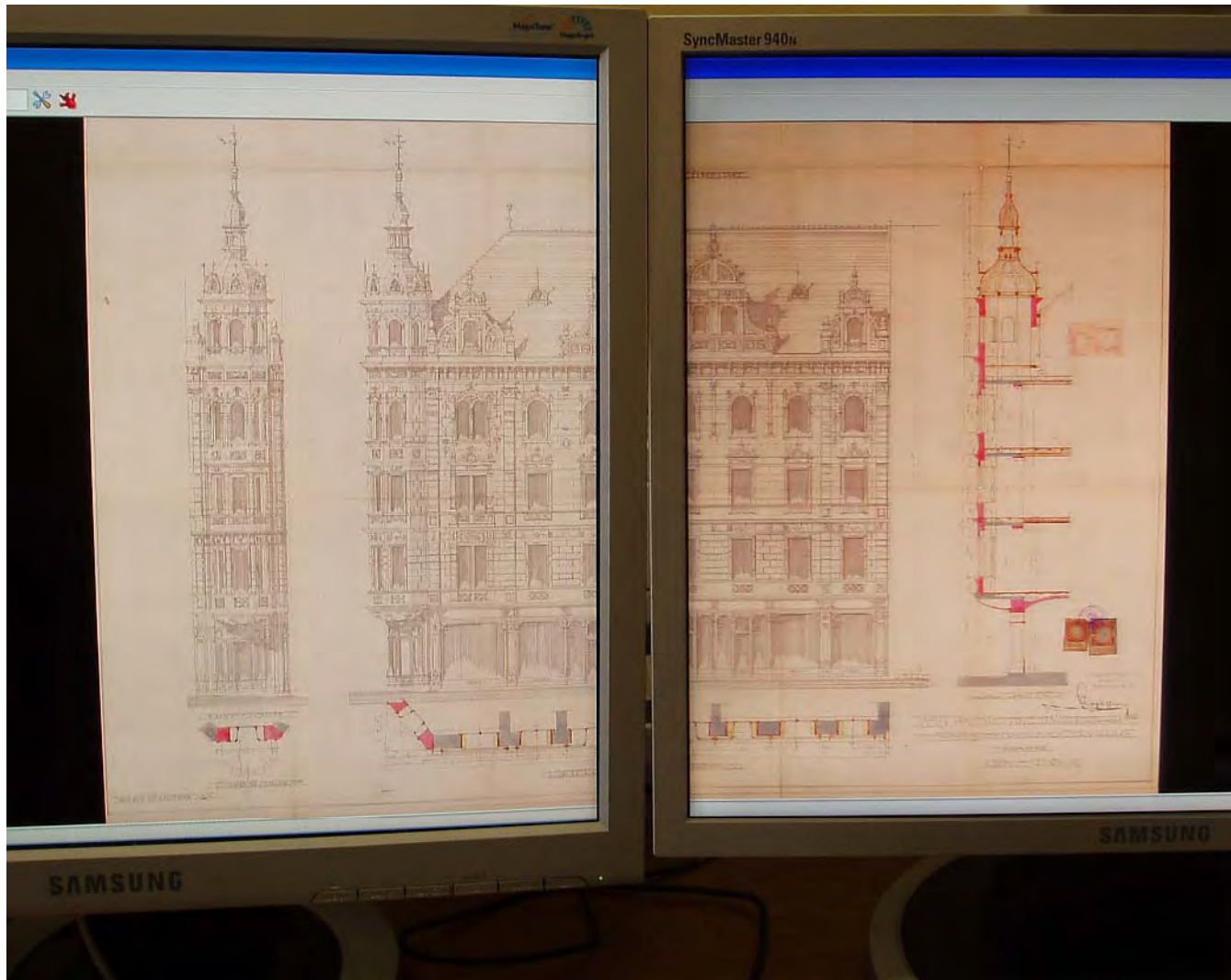



# CASE: DIGITALISATION...

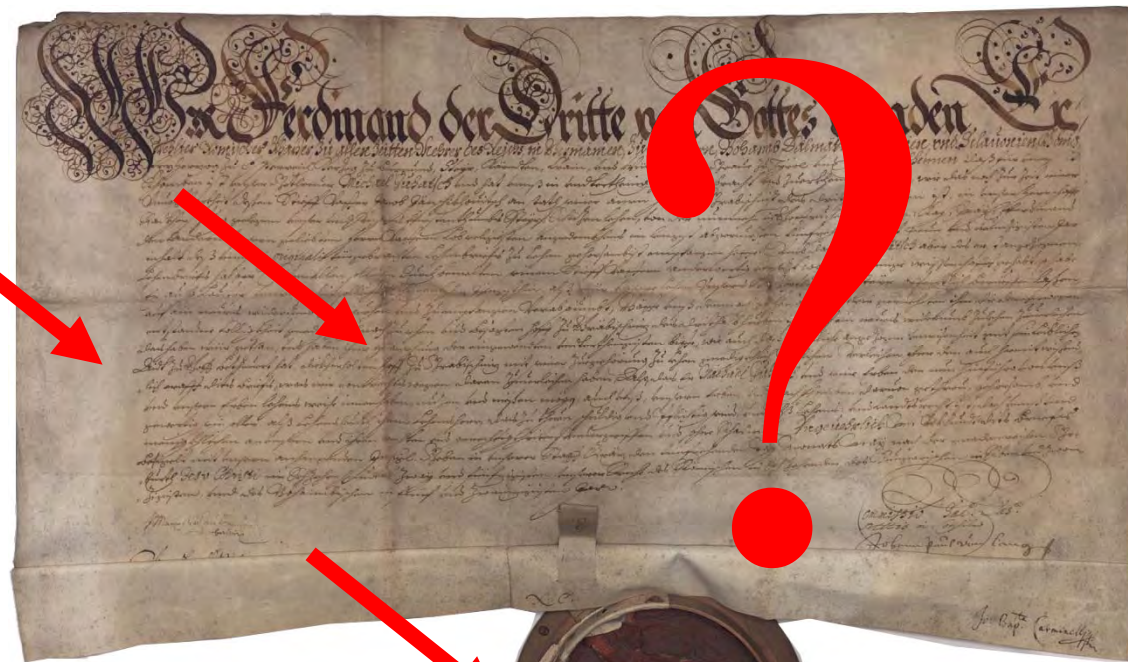

- CONTENT
- ARCHIVAL CONTEXT
- CARRIER
- COLOR
- MEASURE



bela		25% sivina			50% sivina		75% sivina		črna
1	2	3	4	5	cm	[tanova, ki hrani skenirani dokument]			

# CASE: DIGITALISATION...

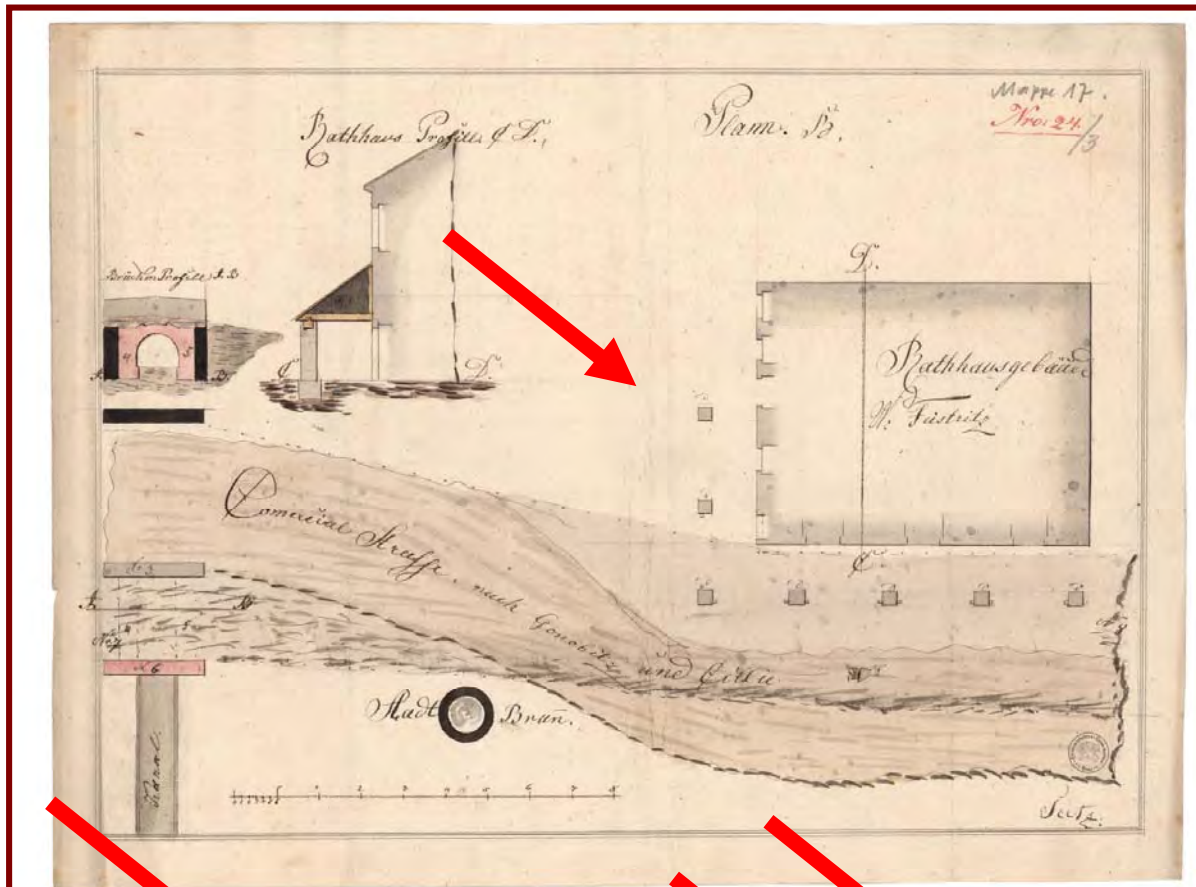

- CARRIER
- COLOR
- GRayscale
- MEASURE



# CASE: DIGITALISATION...

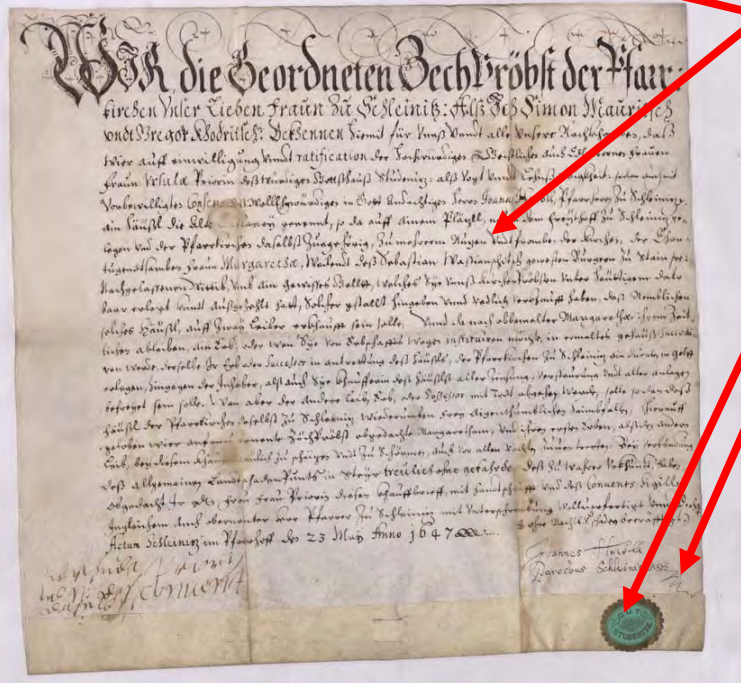
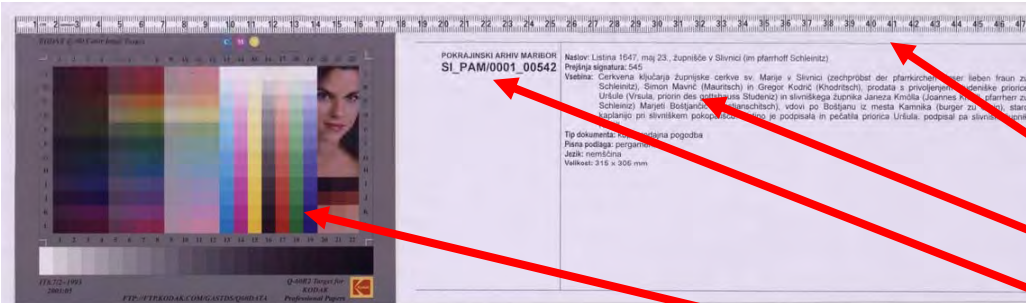

- MEASURE
- CONTENT
- ARCHIVAL CONTEXT
- COLOR
- CARRIER

# POSSIBLE SOLUTION...

---

**S**ecurity

**P**rofessionalism

**S**tandardisation



# INFORMATION PACKAGE...

---

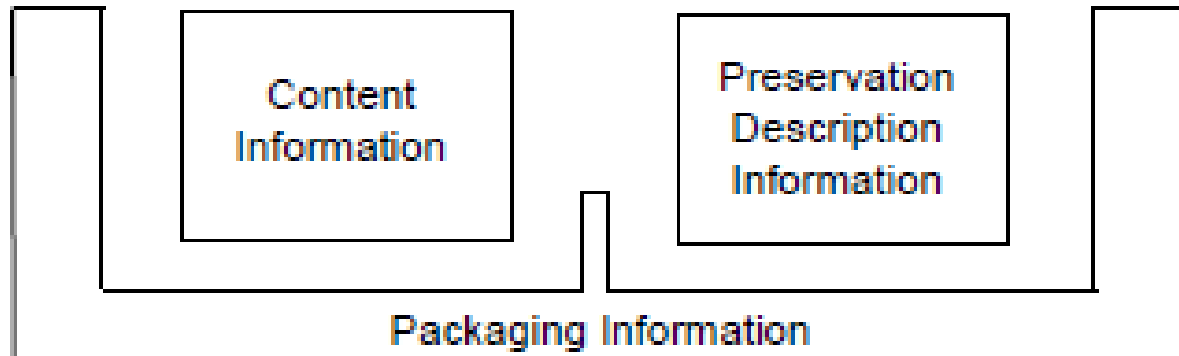

Package 1



Descriptive  
Information  
about Package 1

# INFORMATION PACKAGE...

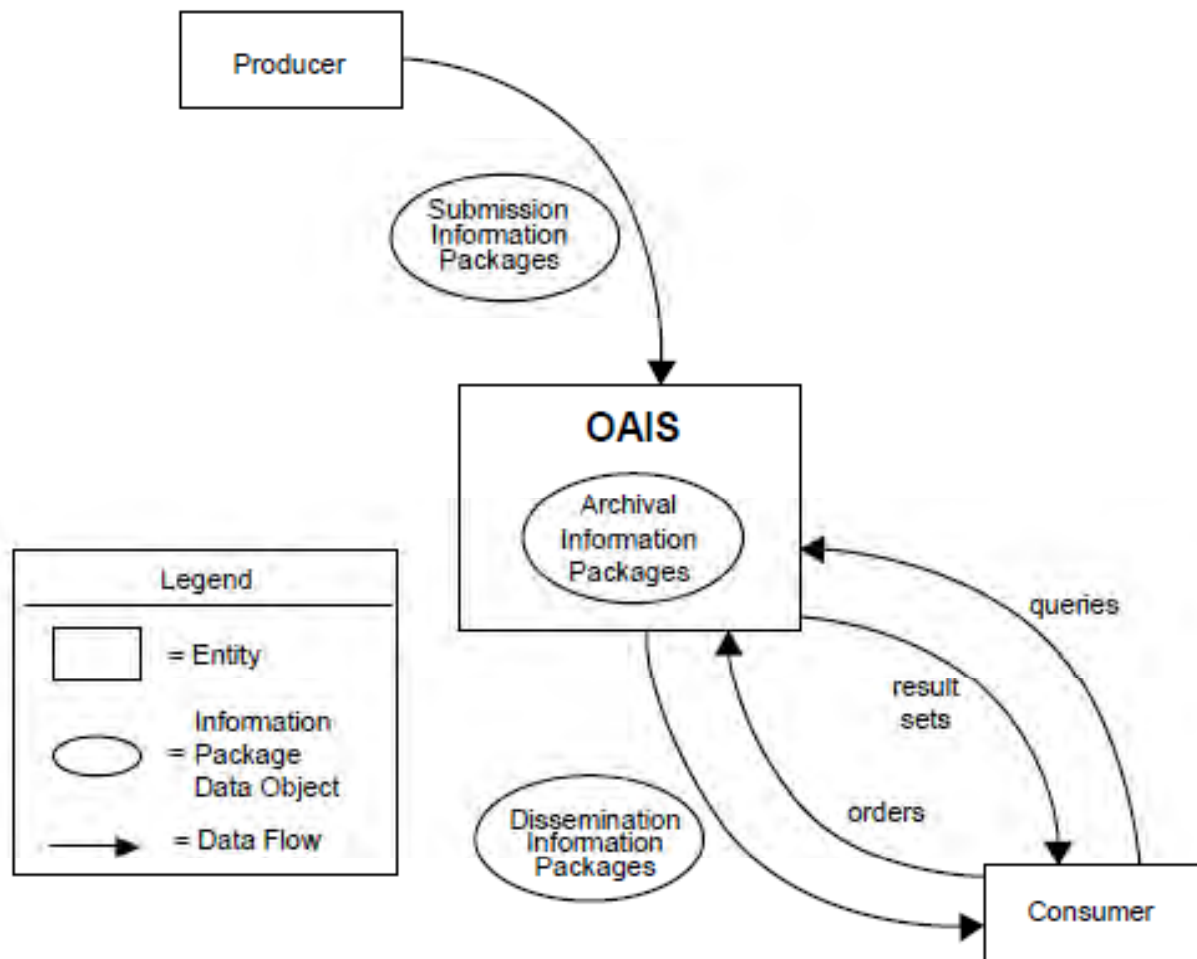

# INFORMATION PACKAGE...

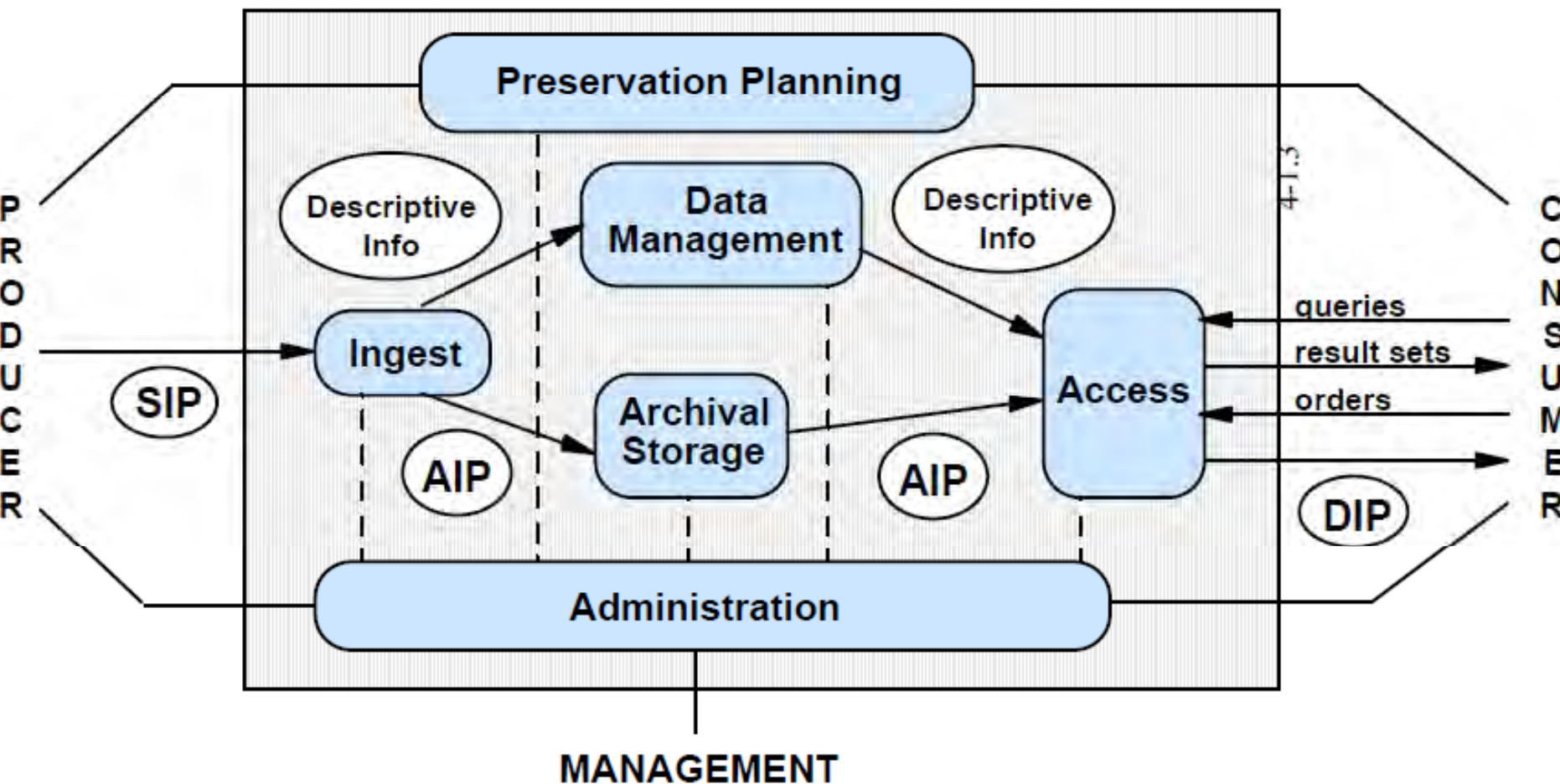



# INFORMATION PACKAGE CONTENTS...

